

Arquivo morto, sala licitação



PREFEITURA MUNICIPAL DE SERRITA-PE  
CNPJ: 11.361.250/0001-73

RESPONSÁVEL PÚBLICO:  
Sebastião Benedito dos Santos

Responsável Técnico:  
Viviana Miranda Queiroz  
Arquiteta do Município  
CAU: nº A254802-0

MOBÉIS PREFEITURA  
MESA COMPARTILHADA

05/11

OUTUBRO 2024

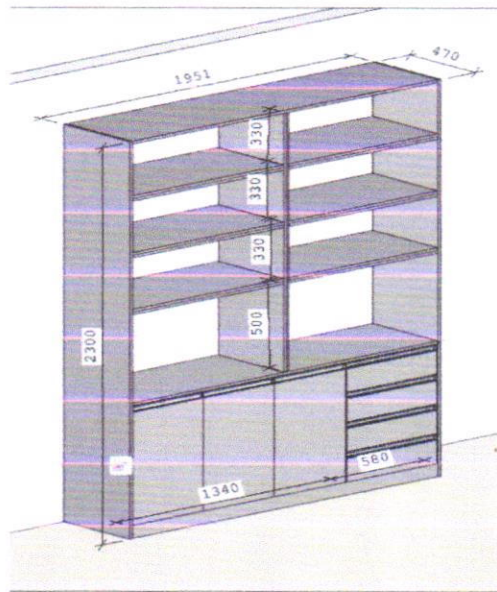
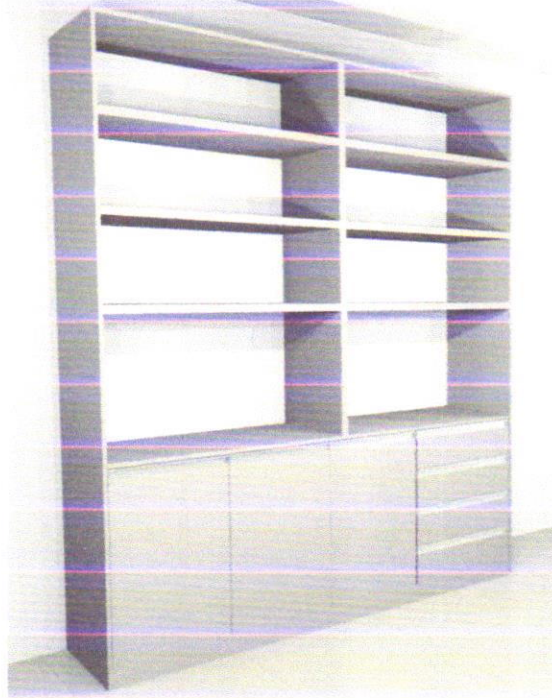

Armário para contabilidade



PREFEITURA MUNICIPAL DE SERRITA-PE  
CNPJ: 11.361.350/0001-73

RESPONSÁVEL PÚBLICO:  
Sebastião Benedito dos Santos

Responsável Técnica:  
Vitória Miranda Queiroz  
Arquiteta do Município  
CAU. nº A254002-9

MOVES PREFEITURA  
MESA COMPARTILHADA

05/11

OUTUBRO 2024

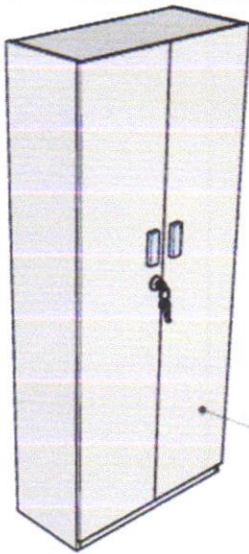

ARMÁRIO 04  
PERSPECTIVA  
ESCALA 1:25

MDF GUARÁRAPS MILANO

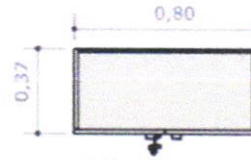

ARMÁRIO 04  
VISTA SUPERIOR  
ESCALA 1:25

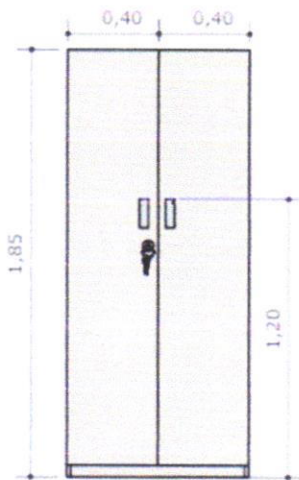

ARMÁRIO 04  
VISTA FRONTAL 1  
ESCALA 1:25

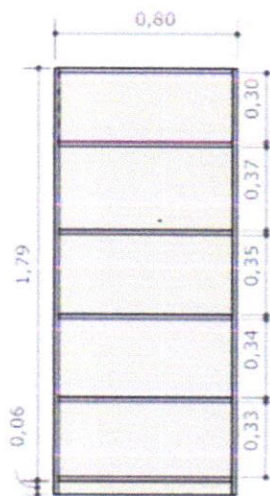

ARMÁRIO 04  
VISTA FRONTAL 2  
ESCALA 1:25

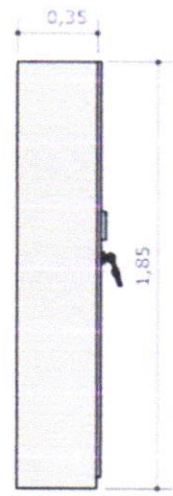

ARMÁRIO 04  
VISTA LATERAL  
ESCALA 1:25



PREFEITURA MUNICIPAL DE SERRITA-PE  
CNPJ: 11.361.250/0001-73

RESPONSÁVEL PÚBLICO:  
Sebastião Benedito dos Santos

Responsável Técnico:  
Vitória Miranda Queiroz  
Arquiteta do município  
CAU: nº A254002-9

MOVEIS PREFEITURA

ARMÁRIO

04/11

OUTUBRO 2024

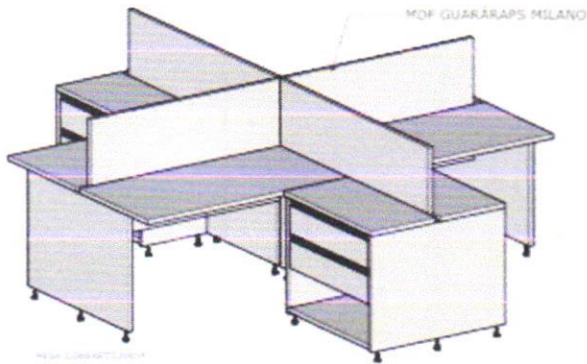

MESA COMPARTILHADA  
MDF MILANO  
LATA 1,20

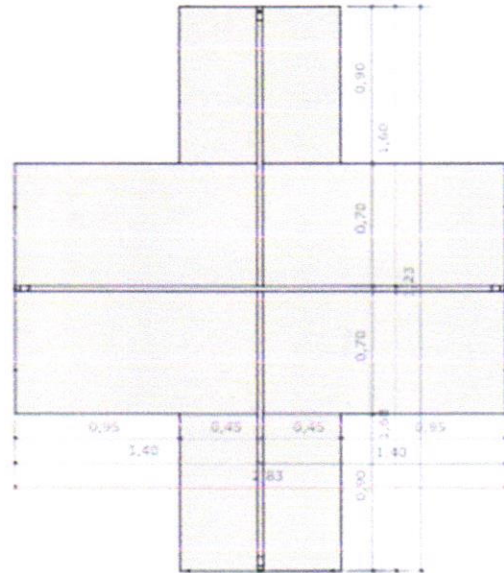

MESA COMPARTILHADA  
MDF MILANO  
LATA 1,20

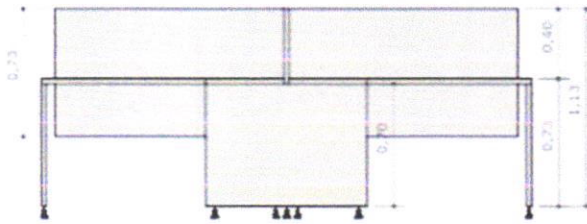

MESA COMPARTILHADA  
MDF MILANO  
LATA 1,20

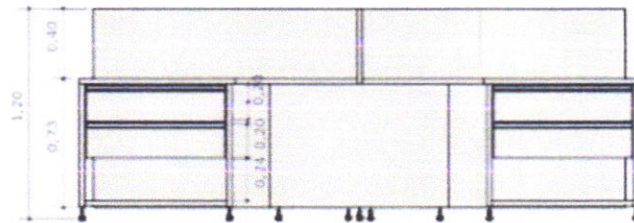

MESA COMPARTILHADA  
MDF MILANO  
LATA 1,20



PREFEITURA MUNICIPAL DE SERRITA-PE  
CNPJ: 11.361.250/0001-73  
RESPONSÁVEL PÚBLICO:  
Sebastião Benedito dos Santos

Responsável Técnico:  
Vitoria Miranda Queiroz  
Arquiteta do Município  
CAU: nº A254882-9

MOVEIS PREFEITURA  
MESA COMPARTILHADA

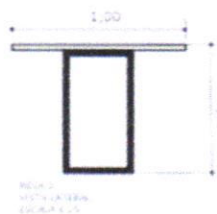
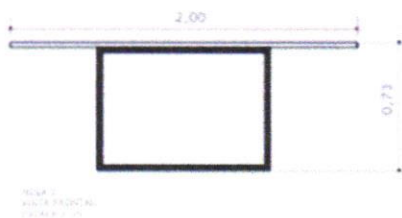
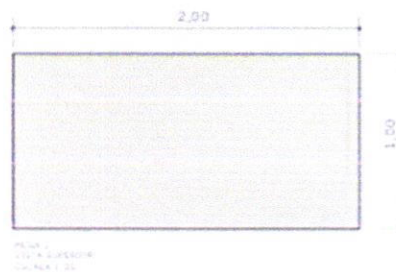
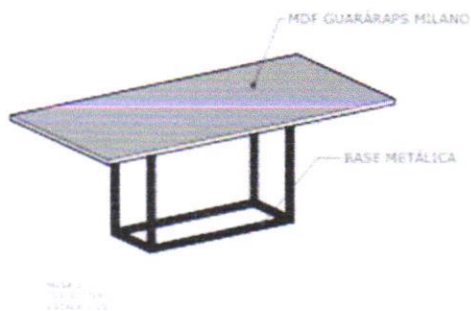
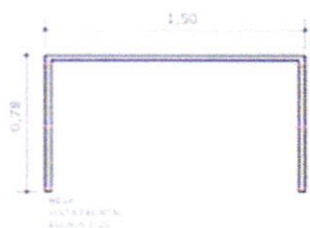
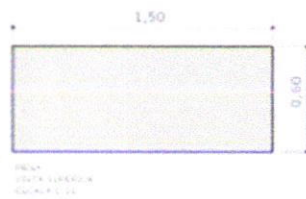
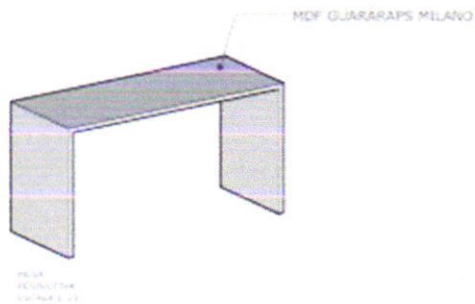

PREFEITURA MUNICIPAL DE SERRITA-PE  
 CNPJ: 11.361.250/0001-73  
 RESPONSÁVEL PÚBLICO:  
 Sebastião Benedito dos Santos

Responsável Técnica:  
 Vitoria Miranda Quirino  
 Arguta da Município  
 CAU: nº A254002-9

MOBILS PREFEITURA  
 MESA 1  
 MESA 2

06/11

OUTUBRO 2024

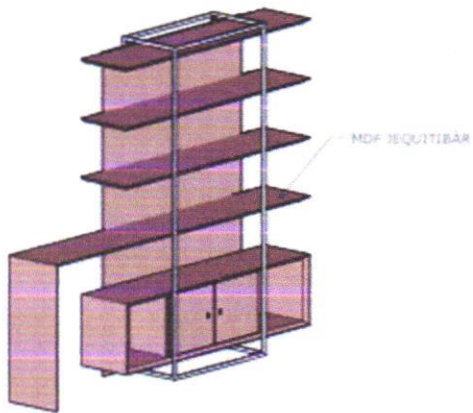

ARMÁRIO DO GABINETE  
VISTA LATERAL  
ESCALA 1:20

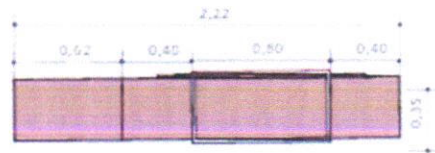

ARMÁRIO DO GABINETE  
VISTA SUPERIOR  
ESCALA 1:20

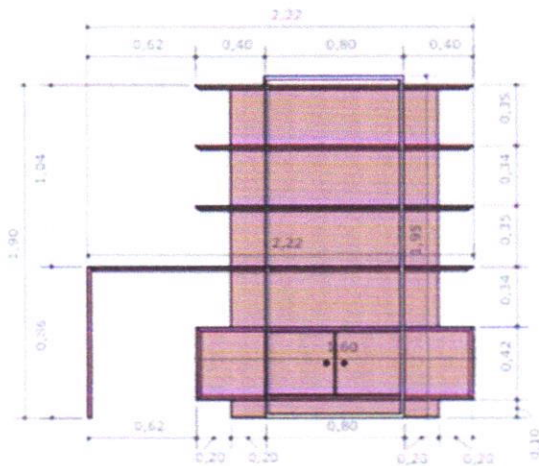

ARMÁRIO DO GABINETE  
VISTA FRONTAL  
ESCALA 1:20

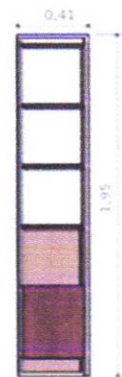

ARMÁRIO DO GABINETE  
VISTA LATERAL  
ESCALA 1:20



PREFEITURA MUNICIPAL DE SERRITA-PE  
CNPJ: 11.361.250/0001-73  
RESPONSÁVEL PÚBLICO:  
Sebastião Benedito dos Santos

Responsável Técnico:  
Vitória Miranda Queiroz  
Arquiteta do município  
CAU: nº A254882-9

MOBÍLIAS PREFEITURA  
ARMÁRIO DO GABINETE

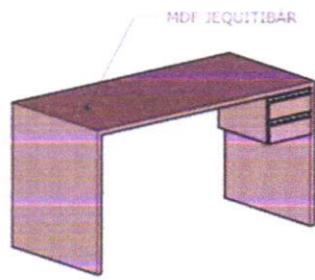

MESA DO CHEFE DE GABINETE  
PERSPECTIVA  
ESCALA 1:25

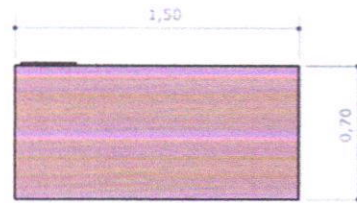

MESA DO CHEFE DE GABINETE  
VISTA SUPERIOR  
ESCALA 1:25

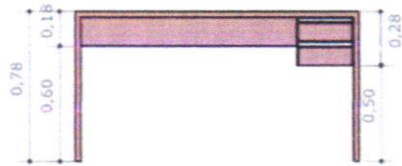

MESA DO CHEFE DE GABINETE  
VISTA FRONTAL  
ESCALA 1:25

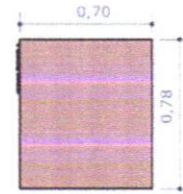

MESA DO CHEFE DE GABINETE  
VISTA LATERAL  
ESCALA 1:25



PREFEITURA MUNICIPAL DE SERRITA-PE  
CNPJ: 11.361.250/0001-73

RESPONSÁVEL PÚBLICO:  
Sebastião Benedito dos Santos

Responsável Técnico:  
Vitória Miranda Queiroz  
Arquiteta do município  
CAU: nº A254002-9

MOVEIS PREFEITURA  
MESA DO GABINETE  
MESA DO CHEFE DE GABINETE



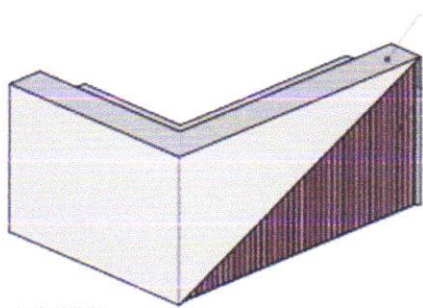

MDF GUARARAPIS MILANO

RIPADO EM MDF ZE TUITISAR

ANEXO 03 - SEÇÃO  
FRONTAL DA  
ESQUA - 1/20

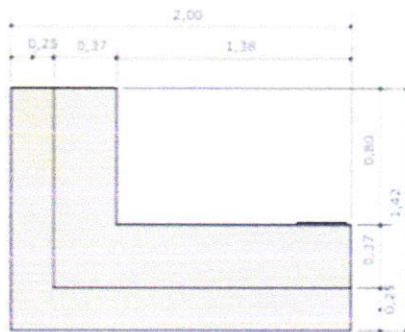

ANEXO 03 - SEÇÃO  
FRONTAL DA  
ESQUA - 1/20

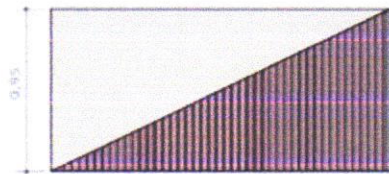

ANEXO 03 - SEÇÃO  
LATERAL DA  
ESQUA - 1/20

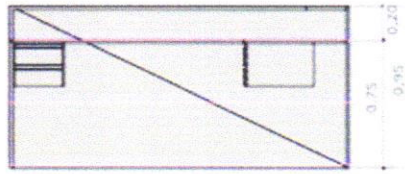

ANEXO 03 - SEÇÃO  
LATERAL DA  
ESQUA - 1/20

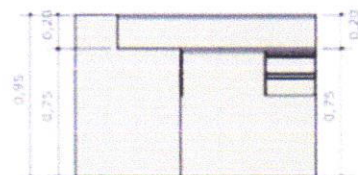

ANEXO 03 - SEÇÃO  
LATERAL DA  
ESQUA - 1/20

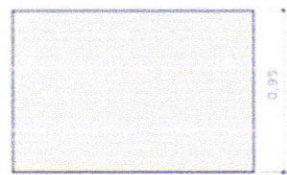

ANEXO 03 - SEÇÃO  
LATERAL DA  
ESQUA - 1/20



PREFEITURA MUNICIPAL DE SERRITA-PE  
CNPJ: 11.361.256/0001-73

RESPONSÁVEL PÚBLICO:  
Selvático Benedito dos Santos

Responsável Técnico:  
Vitória Miranda Queiroz  
Arquiteta de Registro  
CAU: nº 4254602-9

MOBILIÁRIO PREFEITURA  
BALCÃO DA RECEPÇÃO

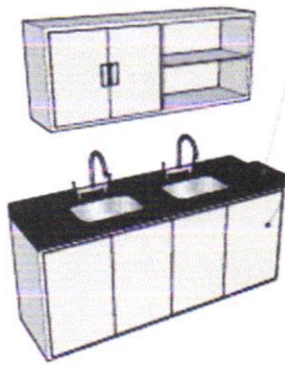

BALCÃO DE GRANITO EXISTENTE

MDF GUARARAPES MILANO

ARMÁRIO COZINHA  
PERSPECTIVA  
ESCALA 1:20

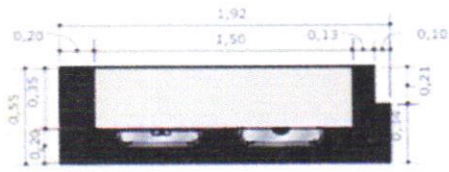

ARMÁRIO COZINHA  
VISTA SUPERIOR  
ESCALA 1:20

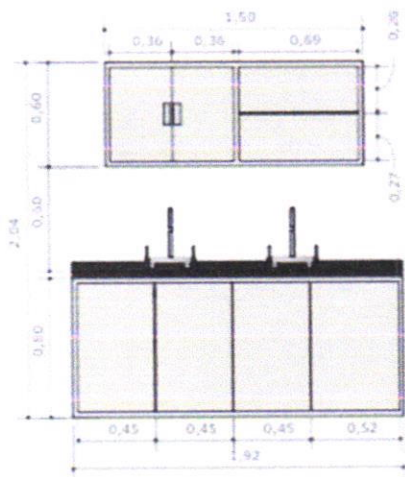

ARMÁRIO COZINHA  
VISTA LATERAL  
ESCALA 1:20

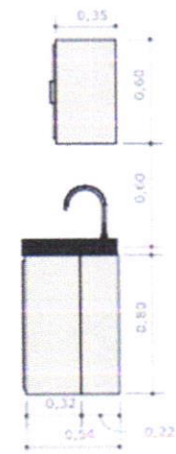

ARMÁRIO COZINHA  
VISTA LATERAL  
ESCALA 1:20

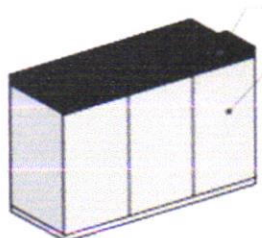

BALCÃO DE GRANITO EXISTENTE

MDF GUARARAPES MILANO

ARMÁRIO COZINHA  
PERSPECTIVA  
ESCALA 1:20



ARMÁRIO COZINHA  
VISTA SUPERIOR  
ESCALA 1:20

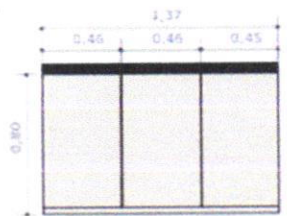

ARMÁRIO COZINHA  
VISTA LATERAL  
ESCALA 1:20

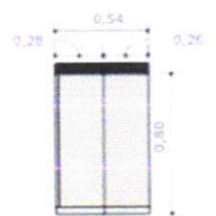

ARMÁRIO COZINHA  
VISTA LATERAL  
ESCALA 1:20



PREFEITURA MUNICIPAL DE SERRITA-PE  
CNPJ: 11.361.250/0001-73  
RESPONSÁVEL PÚBLICO:  
Sebastião Benedito dos Santos

Responsável Técnico:  
Vitória Miranda Queiroz  
Arquiteta do município  
CAU: nº A254002-9

MOVEIS PREFEITURA  
BALCÃO COZINHA

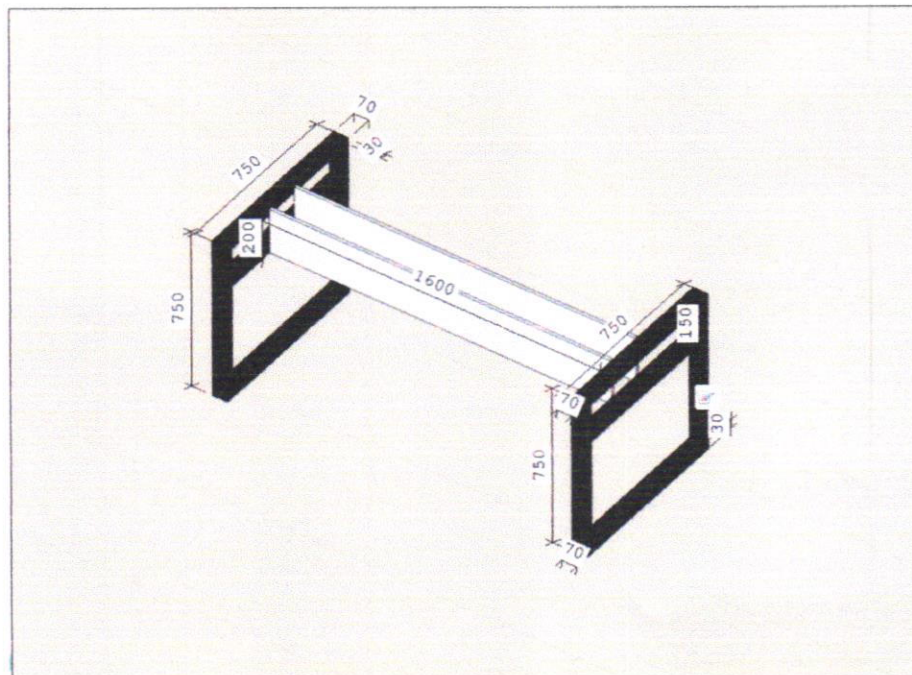
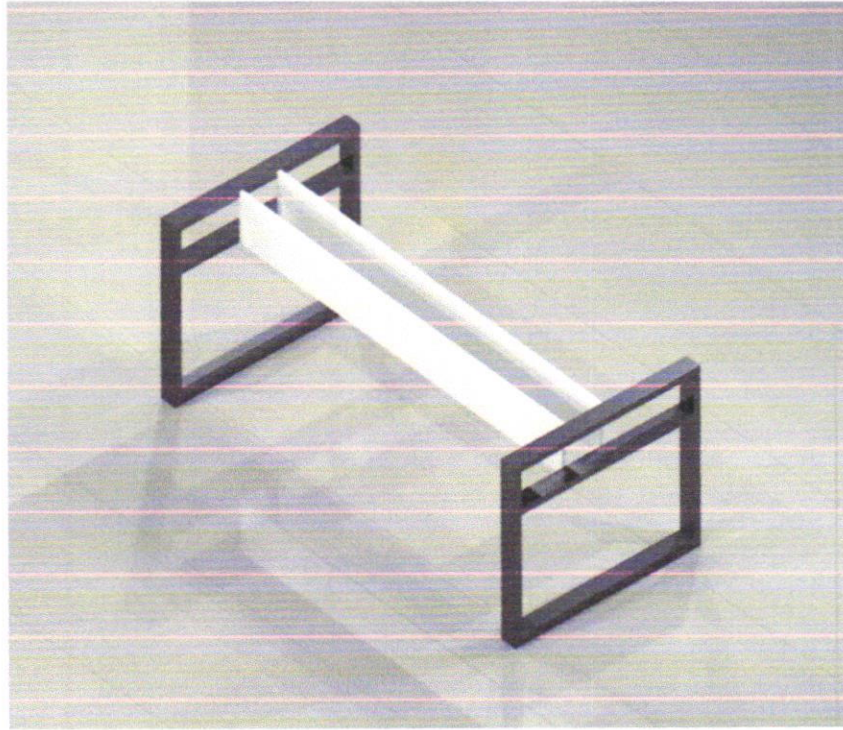

Base metálica para mesa do gabinete do prefeito, pintura preto fosco.

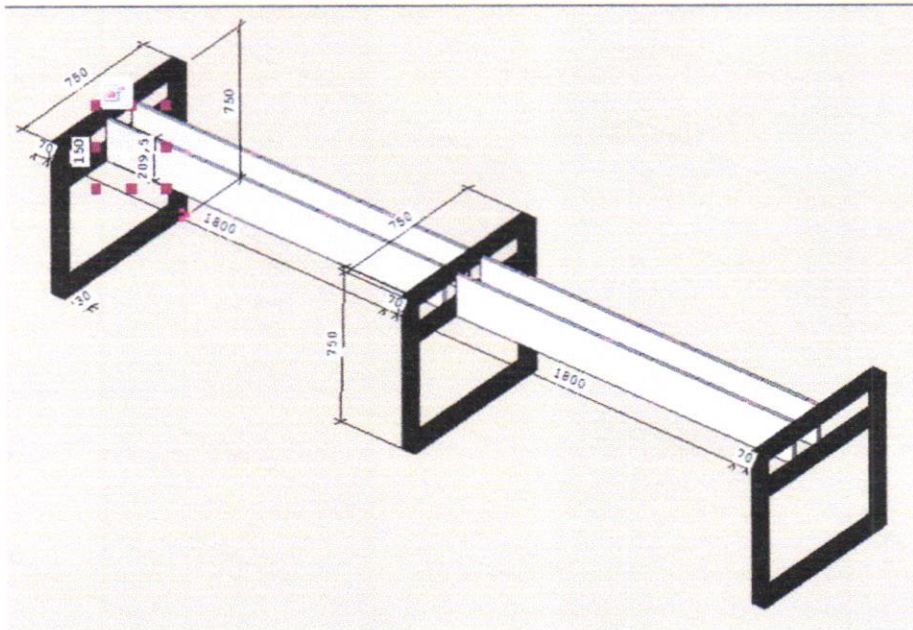
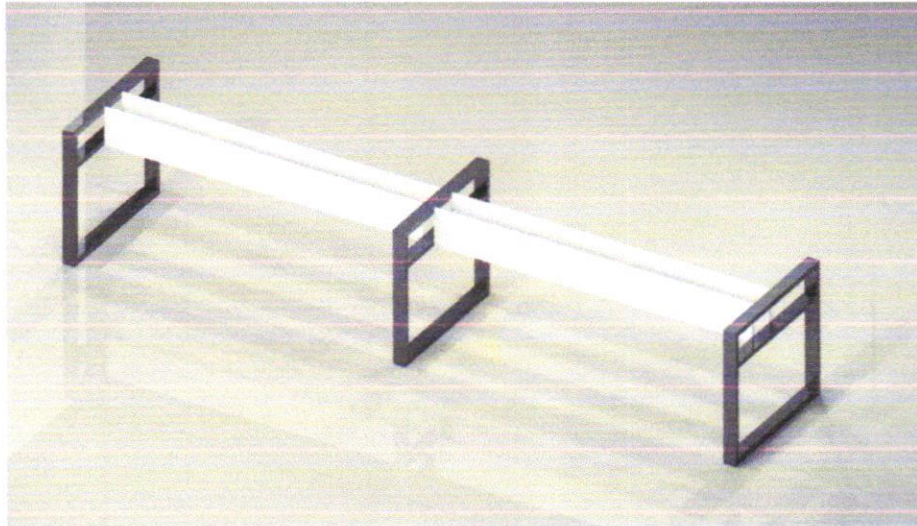

Base metálica para mesa de reunião, pintura preto fosco



PREFEITURA MUNICIPAL DE SERRITA-PE  
CNPJ: 11.361.250/0001-73

RESPONSÁVEL PÚBLICO:  
Sebastião Benedito dos Santos

Responsável Técnico:  
Vitória Miranda Queiroz  
Arquiteta do município  
CAU: nº A254002-9

MOVEIS PREFEITURA  
MESA DO GABINETE  
MESA DO CHEFE DE GABINETE

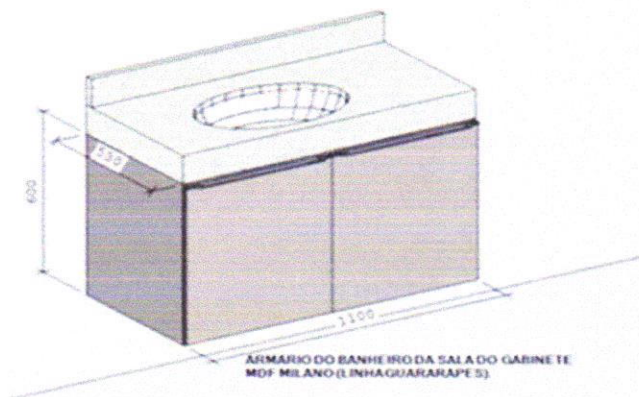
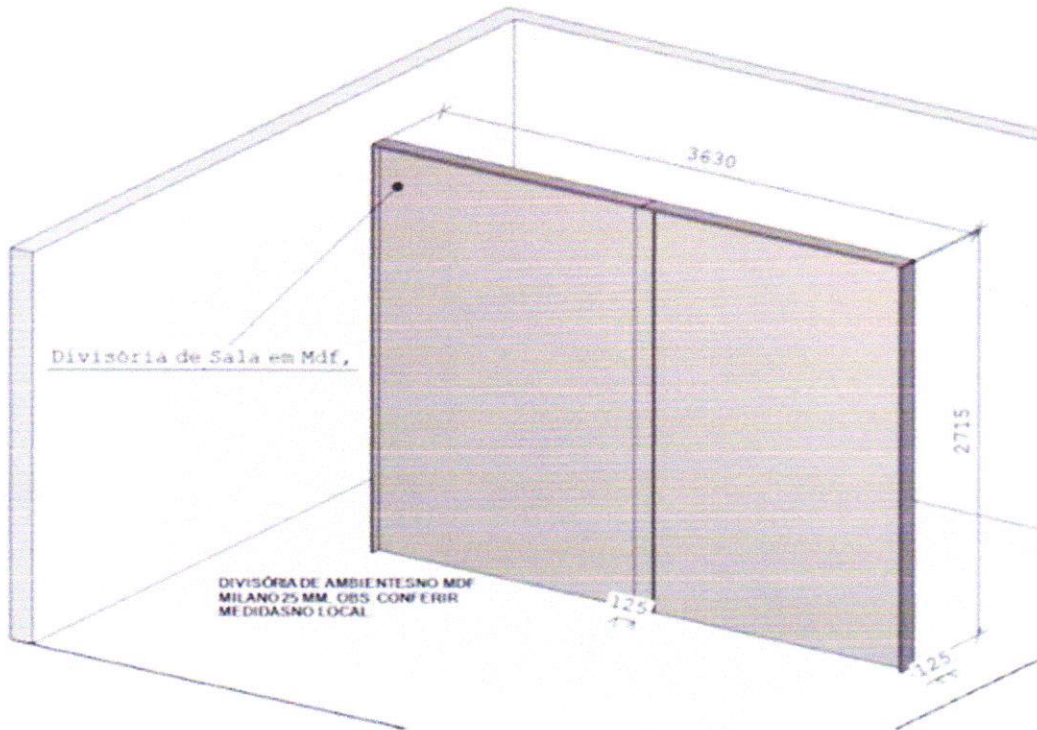

PREFEITURA MUNICIPAL DE SERRITA - PE  
CNPJ: 11.361.250/0001-73

RESPONSÁVEL PÚBLICO:  
Sebastião Benedito dos Santos

Responsável Técnico:  
Vitoria Miranda Queiroz  
Arquiteta do município  
CAU: nº A254002-9

MOVEIS PREFEITURA  
MESA DO GABINETE  
MESA DO CHEFE DE GABINETE

09/11

OUTUBRO 2024